

Specification Sheet

IY180E Industrial Washer



IY180E

Capacity (Dry)	18 kg
Volume	180 L
Spin Type	High Spin
Door Opening	Ø 460 mm
Net Weight	380 kg
Electrical Recommendations	32 Amp – 415 Volt – 3-phase Isolating Switch at 1.8m off floor
Water Recommendations (Hot)	1x Standard 19mm Washing Machine Tap
Water Recommendations (Cold)	2x Standard 19mm Washing Machine Tap
Water Pressure	Minimum = 44PSI (3 Bar), Maximum = 72PSI (5 Bar)
Drain	Ø 76mm through floor
Foundations	Minimum 100mm M20 Grade Concrete Foundation
Optional Plinth	360 mm (height) 6 mm (thickness) Ø 16 mm (bolt hole)

IY180E

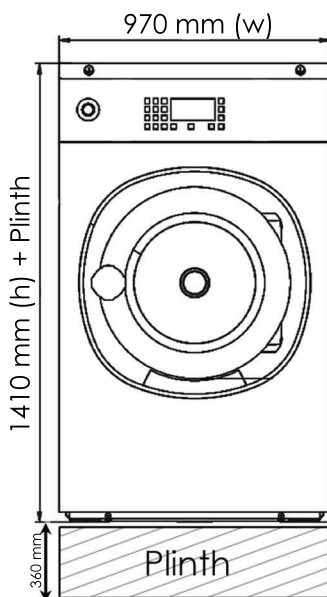

FRONT

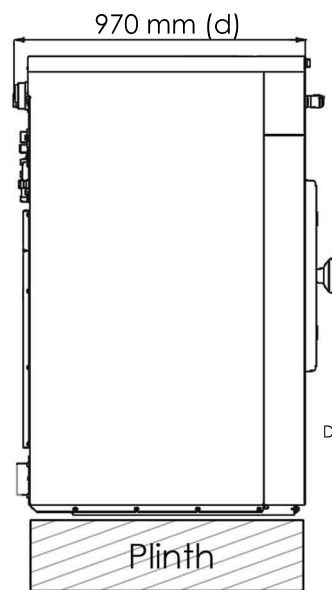

SIDE

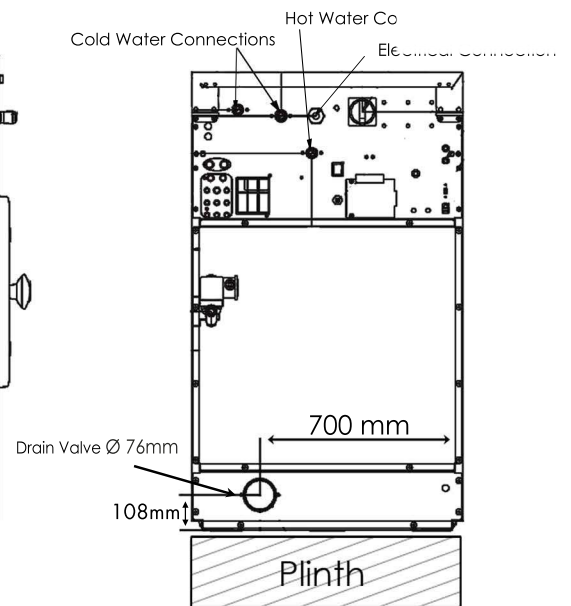

BACK



B-Electrical
Services

EnviroSaver
Ozone Laundry Disinfection

Tel: (08) 8337 7394
(08) 8337 7216
www.b-electrical.com.au